

UKパンチングシリーズ

ステンレス製パンチング板

金網製の煮籠のように針金が折損して、煮炊物の中に入り込む心配はありません。耐久力抜群にて、錆びに強く衛生的です。



パンチングシリーズのパンチ材は網に比べ、

- 針金が折れて食べ物に入り込む心配が無い
- ほつれが無い
- 目詰まりしにくい
- 水切れが良く洗しやすい
- 錆びに強く衛生的
- 耐久力抜群

KITCHEN UTENSIL

パンチングシリーズは、丸穴7種類と角穴11種類の穴径の材質を使い、それぞれの用途に適した材料を選定して商品を開発しています。



1.1φ2P

【標準仕様穴径】1.1mm 2ピッチ
【材質】SUS-304
(18-8Stainless steel)
※板厚は0.5mmにのみ対応します。



1.5φ3P

【標準仕様穴径】1.5mm 3ピッチ
【材質】SUS-304
(18-8Stainless steel)

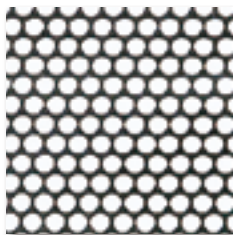

2.2φ4P

【標準仕様穴径】2.2mm 4ピッチ
【材質】SUS-304
(18-8Stainless steel)

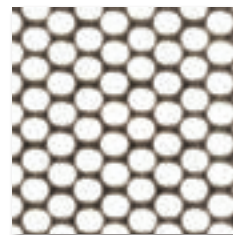

3φ4P

【標準仕様穴径】3.0mm 4ピッチ
【材質】SUS-304
(18-8Stainless steel)

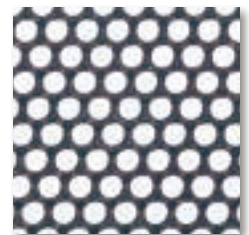

3φ5P

【標準仕様穴径】3.0mm 5ピッチ
【材質】SUS-304
(18-8Stainless steel)
※特注扱いです

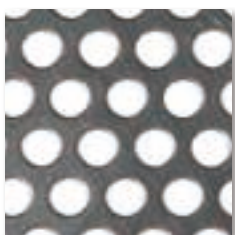

5φ8P

【標準仕様穴径】5.0mm 8ピッチ
【材質】SUS-304
(18-8Stainless steel)
※特注扱いです



6φ9P

【標準仕様穴径】6.0mm 9ピッチ
【材質】SUS-304
(18-8Stainless steel)
※特注扱いです

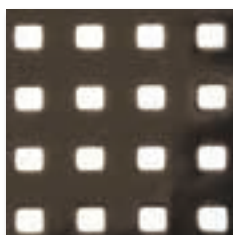

角穴 3×3mm

【標準仕様穴径】3.0×3.0mm
【材質】SUS-304
(18-8Stainless steel)

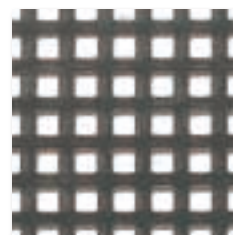

角穴 3.5×3.5mm

【標準仕様穴径】3.5×3.5mm
【材質】SUS-304
(18-8Stainless steel)

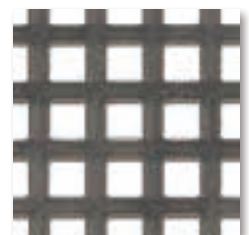

角穴 5×5mm

【標準仕様穴径】5.0×5.0mm
【材質】SUS-304
(18-8Stainless steel)

特注でさまざまなご要望にお応えいたします



■手差しハンドルもできます



■ハンドルも特注できます



■角穴タイプもできます



揚げザルに
限ります

■穴の大きさも
変えられます

揚げザルに
限ります



※製造上、目の形、大きさが異なる場合があります。
※表示以外の目の大きさについては、ご相談ください。

※特注で、目の大きさは変更できます。
※ピッチとは、穴の中心から穴の中心の距離です。



角穴 10×10mm

【標準仕様穴径】10.0×10.0mm
【材質】SUS-304
(18-8Stainless steel)



長角穴 3×30mm

【標準仕様穴径】3.0×30.0mm
【材質】SUS-304
(18-8Stainless steel)

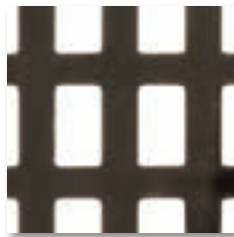

長角穴 6×10mm

【標準仕様穴径】6.0×10.0mm
【材質】SUS-304
(18-8Stainless steel)

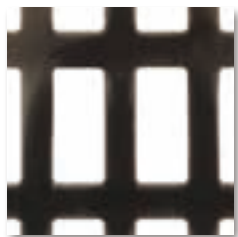

長角穴 6×15mm

【標準仕様穴径】6.0×15.0mm
【材質】SUS-304
(18-8Stainless steel)



長角穴 6×30mm

【標準仕様穴径】6.0×30.0mm
【材質】SUS-304
(18-8Stainless steel)



長角穴 4×35mm

【標準仕様穴径】4.0×35.0mm
【材質】SUS-304
(18-8Stainless steel)



角穴 20×20mm

【標準仕様穴径】20.0×20.0mm
【材質】SUS-304
(18-8Stainless steel)



長角穴 6×80mm

【標準仕様穴径】6.0×80.0mm
【材質】SUS-304
(18-8Stainless steel)

PUNCHING SERIES (ST.ST)



COLANDER/W/PROTECTION
揚げザル/横ビード補強入

0990 7400	42 cm	¥40,000	¥42,000
●42φ×H31 (cm)			
0990 7401	45	¥41,200	¥43,200
●45φ×H31			
0990 7402	48	¥42,400	¥44,600
●48φ×H31			
0990 7403	51	¥44,700	¥47,000
●51φ×H31 (5.0φ) (2.2φ)			
●0.7t (5.0φ)			



COLANDER/W/PROTECTION
揚げザル/縦ビード補強入

0990 7410	42 cm	¥40,000	¥42,000
●42φ×H31 (cm)			
0990 7411	45	¥41,200	¥43,200
●45φ×H31			
0990 7412	48	¥42,400	¥44,600
●48φ×H31			
0990 7413	51	¥44,700	¥47,000
●51φ×H31 (5.0φ) (2.2φ)			
●0.7t (5.0φ)			



COLANDER/W/PROTECTION
揚げザル/深型(補強付)

0990 7482	42 cm	¥41,200	¥43,200
●42φ×H31 (cm)			
0990 7485	45	¥42,400	¥44,600
●45φ×H31			
0990 7488	48	¥43,600	¥45,700
●48φ×H31			
0990 7491	51	¥45,900	¥48,200
●51φ×H31 (5.0φ) (2.2φ)			
●0.7t (5.0φ)			



COLANDER
揚げザル/深型

0990 7442	42 cm	¥37,700	¥38,900	¥40,000
●42φ×H31 (cm)				
0990 7445	45	¥38,900	¥40,000	¥41,200
●45φ×H31				
0990 7448	48	¥40,000	¥41,300	¥42,500
●48φ×H31				
0990 7451	51	¥43,600	¥44,900	¥46,200
●51φ×H31 (5.0φ) (3.0φ) (2.2φ)				
●0.7t (5.0φ)				



COLANDER/W/PROTECTION
揚げザル/深型(補強付)

0990 7520	42 cm	¥44,300
●42φ×H31 (cm)		
0990 7521	45	¥45,400
●45φ×H31		
0990 7522	48	¥46,600
●48φ×H31		
0990 7523	51	¥49,000
●51φ×H31		
●0.7t 10φ 20P		



COLANDER
揚げザル/深型 パイプハンドル

0990 7540	42 cm	¥41,200	¥43,700
●42φ×H31 (cm)			
0990 7541	45	¥42,400	¥44,600
●45φ×H31			
0990 7542	48	¥43,600	¥45,700
●48φ×H31			
0990 7543	51	¥47,000	¥49,500
●51φ×H31 (5.0φ) (2.2φ)			
●0.7t (5.0φ)			



COLANDER
揚げザル/深型(手差しハンドル)

0990 7420	42 cm	¥47,000
●42φ×H31 (cm)		
0990 7421	45	¥48,300
●45φ×H31		
0990 7422	48	¥51,000
●48φ×H31		
0990 7423	51	¥53,000
●51φ×H31		
●0.7t 3.5×3.5角穴		





COLANDER
揚げザル/平底

0990 7245	45 cm	¥35,400	¥36,400	¥37,500
●45φ×H17.5(cm)				
0990 7248	48	¥36,600	¥37,700	¥38,900
●48φ×H18				
0990 7251	51	¥39,100	¥40,000	¥41,500
●51φ×H19.5				
0990 7255	55	¥47,300	¥48,700	¥50,000
●55φ×H20				
0990 7260	60	¥53,000	¥54,700	¥56,300
●60φ×H22				
0990 7265	65	¥59,000 (5.0φ)	¥61,000 (3.0φ)	¥62,600 (2.2φ)
●65φ×H23 ●0.7t (2.2φ) *特注サイズもできます				



COLANDER/W/PROTECTION
揚げザル/平底(補強付)

0990 7275	45 cm	¥36,600	¥37,700	¥38,800
●45φ×H17.5(cm)				
0990 7278	48	¥37,700	¥38,900	¥40,000
●48φ×H18				
0990 7281	51	¥41,300	¥42,500	¥43,900
●51φ×H19.5				
0990 7285	55	¥49,600	¥51,000	¥52,500
●55φ×H20				
0990 7290	60	¥54,300	¥56,100	¥57,800
●60φ×H22				
0990 7295	65	¥60,000 (5.0φ)	¥62,000 (3.0φ)	¥63,900 (2.2φ)
●65φ×H23 ●0.7t (2.2φ) *特注サイズもできます				



COLANDER
揚げザル/平底 パイプハンドル

0990 7370	45 cm	¥35,400
●45φ×H17.5(cm)		
0990 7371	48	¥38,900
●48φ×H18		
0990 7372	51	¥40,000
●51φ×H19.5		
0990 7373	55	¥48,400
●55φ×H20		
0990 7374	60	¥54,200
●60φ×H22		
0990 7375	65	¥60,000
●65φ×H23 ●0.7t 10φ 15P *特注サイズもできます		



COLANDER
揚げザル/平底

0990 7320	45 cm	¥43,600
●45φ×H17.5(cm)		
0990 7321	48	¥44,800
●48φ×H18		
0990 7322	51	¥49,500
●51φ×H19.5		
0990 7323	55	¥55,400
●55φ×H20		
0990 7324	60	¥61,200
●60φ×H22		
0990 7325	65	¥67,100
●65φ×H23 ●0.7t 3.5×3.5角穴 *特注サイズもできます		



*特注で固定式
ハンドルもできます。

COLANDER
揚げザル/底バンチング

0990 7340	45 cm	¥38,400
●45φ×H17.5(cm)		
0990 7341	48	¥39,500
●48φ×H18		
0990 7342	51	¥41,800
●51φ×H19.5		
0990 7343	55	¥49,500
●55φ×H20		
0990 7344	60	¥54,200
●60φ×H22		
0990 7345	65	¥60,000
●65φ×H23 ●0.7t 2.2φ *特注品 ●SPECIAL ORDER		



SPINNER
遠心脱水ざる(ハンドル付)

0990 7590 ¥89,500
●外46φ×内45φ×H31(cm)
●特注品
●SPECIAL ORDER



SPINNER
遠心脱水ざる(ハンドルなし)/角淵

0990 7580 ¥83,000
●外50φ×内45φ×H27(cm)
●特注品
●SPECIAL ORDER



SPINNER
遠心脱水ざる(ハンドルなし)/R淵

0990 7581 ¥83,000
●外50φ×内45φ×H27(cm)
●特注品
●SPECIAL ORDER

フチをL字加工することで、水アカ、汚れ等がたまりず、衛生的です。
溶接箇所

フチをL字加工することで、水アカ、汚れ等がたまりず、衛生的です。
溶接箇所



COLANDER/W/PROTECTION
揚げザル/深・深型(補強付)

0990 7531 45 cm ¥65,000
●45φ×H50(cm)
0990 7532 48 ¥68,000
●48φ×H50
0990 7533 51 ¥73,000
●51φ×H50
●0.8t 3.0φ 5P



COLANDER/SQUARE
揚げザル/角型

0990 7210 33 cm ¥32,500
●33×33×H14(cm)
0990 7211 37 ¥42,000
●37.5×37.5×H16.5
0990 7212 43 ¥50,000
●43×43×H18.7
●0.7t 2.2φ



DOLLY
ドローリー

0990 9900 -650 ¥77,500
0990 9902 -510 ¥71,500
0990 9904 -400 ¥68,500
●18-8 キャスター使用
●揚げザル/深型は別売です。

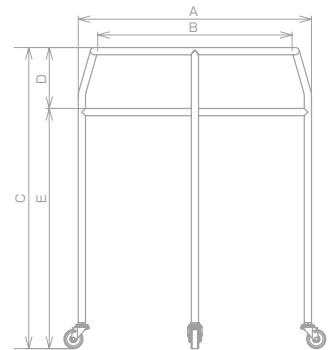

	A 外径(mm)	B 上枠内径(mm)	C 全高(mm)	D 中受深さ(mm)	E 中受高さ(mm)
0990 9900	750	650	810	140	670
0990 9902	610	510	810	140	670
0990 9904	500	400	810	140	670

●キャスター SUS304
●50φ×4/自在 ストッパー付×2 ストッパー無×2



COLANDER
水切りザル

0990 4818	18 cm	¥6,300
●19.5φ×H7.5(cm)	●0.23(kg)	
0990 4821	21	¥6,900
●22.5φ×H8.5	●0.30	
0990 4824	24	¥7,800
●25.5φ×H9.5	●0.38	
0990 4827	27	¥9,950
●28.5φ×H11	●0.48	
0990 4830	30	¥11,500
●32.0φ×H12.5	●0.56	
●0.6t 2.2φ		



COLOR PLATE
コランダ-用 カラープレート

0990 4000	ピンク	¥1,500
0990 4001	ブルー	¥1,500
0990 4002	イエロー	¥1,500
0990 4003	グリーン	¥1,500
●12×1.5(cm)		



COLANDER
浅型ザル

0990 7033	33 cm	¥16,000
●35.5φ×H14(cm)	●0.78(kg)	
0990 7035	35	¥17,500
●37.5φ×H15.5	●0.86	
0990 7037	37.5	¥20,500
●40.0φ×H16	●0.95	
0990 7040	40	¥23,500
●42.5φ×H17	●1.16	
0990 7043	43	¥25,500
●45.5φ×H17.5	●1.32	
0990 7046	46	¥29,000
●48.5φ×H19.5	●1.47	
0990 7050	50	¥33,500
●52.5φ×H21	●1.70	
0990 7055	55	¥43,500
●57.5φ×H21	●2.05	
0990 7060	60	¥47,000
●62.5φ×H22	●2.65	
0990 7065	65	¥51,000
●67.5φ×H22	●2.92	
●0.7t 2.2φ		



●OPTIONAL ハンドル付



COLANDER
浅型ザル/手付(可動式)

0990 7010	40 cm	¥29,000
●42.5φ×H17(cm)	●1.46(kg)	
0990 7013	43	¥31,000
●45.5φ×H17.5	●1.58	
0990 7016	46	¥34,000
●48.5φ×H19.5	●1.75	
0990 7020	50	¥39,000
●52.5φ×H21	●1.97	
0990 7025	55	¥48,500
●57.5φ×H21	●2.39	
●0.7t 2.2φ		



●OPTIONAL パイプハンドル



COLANDER
米揚げザル

0990 7227	27.5 cm	¥19,000
●30.0φ×H16.5(cm)	●容量:3升	●0.65(kg)
0990 7230	30	¥20,000
●32.5φ×H18	●容量:4	●0.80
0990 7233	33	¥21,500
●35.5φ×H20	●容量:5	●0.96
0990 7235	35	¥29,500
●37.5φ×H21.5	●容量:8	●1.07
0990 7237	37.5	¥32,000
●40.0φ×H23	●容量:10	●1.23
●0.7t 1.5φ		



COLANDER
深型ザル

0990 7127	27.5 cm	¥16,900
●30.0φ×H16.5(cm)	●容量:3升	●0.69(kg)
0990 7130	30	¥19,000
●32.5φ×H18	●容量:4	●0.82
0990 7133	33	¥21,000
●35.5φ×H20	●容量:5	●1.05
0990 7135	35	¥26,000
●37.5φ×H21.5	●容量:8	●1.17
0990 7137	37.5	¥30,500
●40.0φ×H23	●容量:10	●1.29
●0.7t 2.2φ		



●OPTIONAL ハンドル付



PUNCHING SERIES (st.st)



COLANDER
手付浅型ザル

0990 6933	33 cm ●35.5 φ×H12.7 (cm) ●0.7t	¥23,000
0990 6935	35 ●37.5 φ×H14 ●0.7t	¥24,000
0990 6937	37.5 ●40.0 φ×H14.6 ●0.7t	¥25,500
0990 6940	40 ●42.5 φ×H15.8	¥28,000
0990 6943	43 ●45.5 φ×H16.2	¥31,000
0990 6946	46 ●48.5 φ×H17.2	¥32,500
0990 6950	50 ●52.5 φ×H19.4 ●0.7t	¥37,000
0990 6955	55 ●57.5 φ×H19.8	¥45,000
0990 6960	60 ●62.5 φ×H20.3	¥49,500
0990 6965	65 ●67.0 φ×H20.5 ●0.8t 脇3φ穴 底4φ穴	¥53,000



●OPTIONAL ハンドル付

COLANDER
巾広浅型ザル

0990 7073	33 cm ●35.5 φ×H14 (cm)	¥16,500
0990 7075	35 ●37.5 φ×H15.5	¥19,600
0990 7077	37.5 ●40.0 φ×H16	¥23,000
0990 7080	40 ●42.5 φ×H17 ●0.7t 2.2φ	¥25,500
0990 7083	43 ●45.5 φ×H17.5	¥27,600
0990 7086	46 ●48.5 φ×H19.5	¥31,000
0990 7090	50 ●52.5 φ×H21	¥36,000
0990 7095	55 ●57.5 φ×H21	¥45,000
0990 7100	60 ●62.5 φ×H22	¥47,500
0990 7105	65 ●67.5 φ×H22 ●0.8t 2.2φ	¥52,000



(0.5t 1.5φ)

COLANDER
揚げザル

0990 6124	24 cm ●26 φ×H7 (cm)	¥5,800
0990 6126	26 ●28 φ×H7.5	¥6,550
0990 6128	28 ●30 φ×H8	¥7,250
0990 6130	30 ●32 φ×H8.5	¥7,800
0990 6133	33 ●35 φ×H9 ●0.5t 1.5φ	¥9,500



(0.5t 1.5φ)

COLANDER
ためザル

0990 6024	24 cm ●26 φ×H1.7 (cm)	¥5,400
0990 6026	26 ●28 φ×H1.9	¥6,000
0990 6028	28 ●30 φ×H2	¥6,600
0990 6030	30 ●32 φ×H2.2	¥7,600
0990 6033	33 ●35 φ×H2.4 ●0.5t 1.5φ	¥9,150



(0.8t 2.2φ)

0990 6143	43 ●43 φ×H14.5	¥20,000
0990 6146	46 ●46 φ×H14.5	¥27,500
0990 6150	50 ●50 φ×H14.5 ●0.8t 2.2φ	¥33,500



(0.8t 2.2φ)

0990 6043	43 ●46 φ×H5.5	¥18,000
0990 6046	46 ●49 φ×H5.5	¥19,000
0990 6050	50 ●53 φ×H5.5 ●0.8t 2.2φ	¥22,500





COLANDER/W/HANDLES
手付パンチボール(手付ボールザル/深型) **NEW**

測巻	HACCP	
15 cm ●16φ×H6.5(cm)	0990 4115 ¥4,550	0990 4140 ¥4,550
18 ●20φ×H7	0990 4118 ¥5,000	0990 4142 ¥5,000
21 ●23φ×H8.5	0990 4121 ¥6,000	0990 4144 ¥6,000
24 ●26φ×H9.5	0990 4124 ¥7,900	0990 4146 ¥7,900
27 ●29φ×H10	0990 4127 ¥10,000	0990 4148 ¥10,000
30 ●32φ×H11.5 ●0.6t 1.5φ	0990 4130 ¥12,500	0990 4150 ¥12,500

●サイズはハンドルを含んでおりません。
※測巻仕様はなくなり次第廃番になり、HACCP仕様のみ取り扱いになります。



HACCPとは

HACCP(ハサップ)は、米国航空宇宙局(NASA)が宇宙食の製造にあたって食品の安全性を確実に保証できる衛生管理手法として開発した方法です。食品の安全性を確保する上で最も効果的な手法であるとして、世界的にも高く評価され、すでに多くの国で導入されています。



COLANDER/ROUND/DEEP
深型パンチボール(ボールザル/深型)

測巻	HACCP	
15 cm ●16φ×H6.5(cm)	0990 4015 ¥2,900	0990 4050 ¥2,900
18 ●20φ×H7	0990 4018 ¥3,550	0990 4052 ¥3,550
21 ●23φ×H8.5	0990 4021 ¥4,450	0990 4054 ¥4,450
24 ●26φ×H9.5	0990 4024 ¥5,800	0990 4056 ¥5,800
27 ●29φ×H10	0990 4027 ¥8,200	0990 4058 ¥8,200
30 ●32φ×H11.5 ●0.6t 1.5φ	0990 4030 ¥10,000	0990 4060 ¥10,000

※測巻仕様はなくなり次第廃番になり、HACCP仕様のみ取り扱いになります。



COLANDER HACCP 水切りボール

0990 5118	18 cm	¥5,750
●20φ×H7(cm)		
0990 5121	21	¥6,450
●23φ×H8		
0990 5124	24	¥7,750
●26.5φ×H9		
0990 5127	27	¥9,850
●29.5φ×H10		
0990 5130	30	¥11,500
●33φ×H11		
●0.6t 2.2φ		

電解仕上



COLANDER HACCP 深型ザル

0990 7150	27.5 cm	¥17,000
●30.0φ×H14.8(cm) ●容量:3升		
0990 7152	30	¥18,500
●32.5φ×H16.3 ●容量:4		
0990 7154	33	¥20,500
●35.5φ×H18 ●容量:5		
0990 7156	35	¥26,000
●37.5φ×H19.5 ●容量:8		
0990 7158	37.5	¥29,500
●40.0φ×H21 ●容量:10		
●0.7t 2.2φ		



COLANDER/ROUND/SALLOW
浅型パンチボール(ボールザル/浅型)

測巻	HACCP	
15 cm ●16φ×H4.7(cm)	0990 4515 ¥2,550	0990 4550 ¥2,850
18 ●20φ×H5.5	0990 4518 ¥3,000	0990 4552 ¥3,300
21 ●23φ×H6.3	0990 4521 ¥3,900	0990 4554 ¥4,300
24 ●26φ×H6.7	0990 4524 ¥5,050	0990 4556 ¥5,500
27 ●29φ×H7.5	0990 4527 ¥7,200	0990 4558 ¥7,600
30 ●32φ×H8.3 ●0.6t 1.5φ	0990 4530 ¥9,000	0990 4560 ¥9,350



COLANDER/ROUND
パンチング盆ザル(盆ザル)

測巻	HACCP	
15 cm ●16φ×H3.4(cm)	0990 4615 ¥2,300	0990 4650 ¥2,500
18 ●20φ×H3.4	0990 4618 ¥2,800	0990 4652 ¥3,000
21 ●23φ×H3.4	0990 4621 ¥3,400	0990 4654 ¥3,700
24 ●26φ×H3.4	0990 4624 ¥4,400	0990 4656 ¥4,650
27 ●29φ×H3.4	0990 4627 ¥6,400	0990 4658 ¥6,500
30 ●32φ×H3.4 ●0.5t 1.5φ	0990 4630 ¥7,850	0990 4660 ¥7,900



COLANDER/ROUND
パンチングそばザル(浅型盆ザル)

測巻	HACCP	
15 cm ●16φ×H1.8(cm)	0990 4715 ¥2,000	0990 4750 ¥2,300
18 ●20φ×H1.8	0990 4718 ¥2,550	0990 4752 ¥2,800
21 ●23φ×H1.8	0990 4721 ¥3,100	0990 4754 ¥3,300
24 ●26φ×H1.8	0990 4724 ¥3,950	0990 4756 ¥4,250
27 ●29φ×H1.8	0990 4727 ¥5,800	0990 4758 ¥5,950
30 ●32φ×H1.8 ●0.5t 1.5φ	0990 4730 ¥6,950	0990 4760 ¥7,200



COLANDER HACCP 浅型ザル

0990 6980	33 cm	¥16,000
●35.5φ×H12(cm)		
0990 6982	35	¥18,500
●37.5φ×H13.5		
0990 6984	37.5	¥20,500
●40.0φ×H14		
0990 6986	40	¥24,000
●42.5φ×H15		
0990 6988	43	¥26,500
●45.5φ×H15.5		
0990 6990	46	¥29,500
●48.5φ×H17.5		
0990 6992	50	¥34,000
●52.5φ×H19		
0990 6994	55	¥43,500
●57.5φ×H19		
0990 6996	60	¥46,500
●62.5φ×H20		
0990 6998	65	¥51,000
●67.5φ×H20		
●0.7t 2.2φ		

※測巻仕様はなくなり次第廃番になり、HACCP仕様のみ取り扱いになります。



COLANDER for STOCK POT
スープ取りザル

0926 3036	36 cm	¥51,200
●35φ×H35 (cm)		
0926 3039	39	¥54,700
●38φ×H38		
0926 3042	42	¥65,400
●41φ×H41		
0926 3045	45	¥73,000
●44φ×H44		
0926 3048	48	¥83,300
●47φ×H47		
●0.7t 2.2φ		
*48cmは受注生産です。		
*特注サイズも出来ます。		



COLANDER for STOCK POT
半丸スープ取りザル

0926 3136	36 cm	¥35,700
●35φ×18×H30 (cm)		
0926 3139	39	¥38,100
●38φ×20×H33		
0926 3142	42	¥43,000
●41φ×21×H36		
0926 3145	45	¥50,000
●44φ×23×H39		
0926 3148	48	¥51,300
●47φ×25×H42		
●0.7t 2.2φ		
*48cmは受注生産です。		
*特注サイズも出来ます。		



COLANDER
蒸しザル(手付)

0990 7350	50 cm	¥58,000
●50φ×H10 (cm)		
0990 7360	60	¥68,500
●60φ×H10		
●0.7t 2.2φ		
*特注サイズも出来ます。		



COLANDER
蒸しザル(手付)

0990 7365		¥114,000
●74φ×64φ×H18 (cm)		
●0.8t 6φ15P		



COLANDER
丸スープ取りザル

0926 3000		¥34,800
●20φ×H29.5 (cm)		
●0.6t 1.5φ		

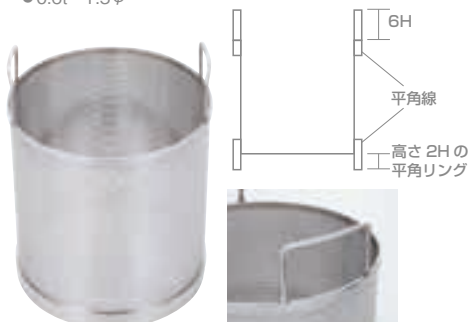

SPAGHETTI BASKET
スパゲッティカゴ

0925 3075		¥38,500
●27.5φ×H29 (cm)		
●0.5t 1.5φ3P		





ROUND FRYER/W/HANDLS
丸フライヤー/ハンドル付

0925 3710 —26 cm	¥10,600
●26φ (cm)	
0925 3720 —28	¥11,400
●28φ	
0925 3730 —30	¥12,000
●30φ	
0925 3740 —33	¥13,000
●33φ	
●0.6t 1.5φ	



ROUND FRYER/W/HANDLS
丸フライヤー/かす揚げ(ハンドル付)

0925 3810 —26 cm	¥9,400
●26φ (cm)	
0925 3820 —28	¥9,800
●28φ	
0925 3830 —30	¥10,500
●30φ	
●0.6t 3.0φ	



丸キッチンポットと組合せて
使用出来ます。



丸キッチンポットと組合せて
使用出来ます。



BOIL-BASKET/Double Handles
ボイルバスケット/両手ハンドル

0925 3122 21cm	¥14,600
●21φ×H18 (cm)	
0925 3125 24	¥16,900
●24φ×H21	
●0.5t 1.5φ	
*特注サイズも出来ます。	



BOIL-BASKET/Singl Handle
ボイルバスケット/片手ハンドル

0925 3115 15 cm	¥10,200
●15φ×H11 (cm)	
0925 3118 18	¥11,400
●18φ×H13	
0925 3121 21	¥14,400
●21φ×H15	
0925 3124 24	¥15,100
●24φ×H16	
●0.5t 1.5φ	
*特注サイズも出来ます。	



BOIL-BASKET
スパゲッティストレーナー

0925 3180	¥17,100
●25φ×H12 (cm)	
handle:25 (cm) 0.6t 1.5φ	



COLANDER for STOCK BASKET
スープ取りカゴ

0926 3090 36 cm	¥82,500
●36φ×H36 (cm)	
0926 3091 57	¥149,000
●57φ×H27	
●0.7t 2.2φ	
*特注品(小豆・大豆煮豆カゴ)	
●SPECIAL ORDER	



COLANDER for STOCK BASKET
スープ取りカゴ

0926 3095 50cm	¥153,000
●50φ×H33.5 (cm)	
*特注品	
●SPECIAL ORDER	





FRYER
ポテトフライヤー

0925 3205-S ¥15,700
●28.5×12.5×H11 (cm) 0.7t 2.2φ
*特注サイズも出来ます。



FRYER
ポテトフライヤー

0925 3200-L ¥17,000
●28.5×17.5×H11 (cm) 0.7t 2.2φ
*特注サイズも出来ます。



BOIL-BASKET
フライドポテトバスケット

0925 3220 ¥16,000
●21×15×H15 (cm) 0.7t 5.0φ



FRYER
フライヤー

0925 3215 ¥21,600
●34×12.3×H12 (cm)
handle:30 (cm) 1.0t 6.0φ



BOIL-BASKET
スパゲッティバスケット

0925 3210 ¥21,300
●29×10×H15 (cm) 0.6t 1.5φ



BOIL-BASKET
冷凍麺てぼ

0925 3400-共柄 ¥12,000
0925 3410-パイプ柄 ¥14,200
●16×4.5×H14 (cm)
handle:17 (cm) 0.6t 2.2φ



BOIL-BASKET
フランクフルトバスケット

0925 3230 ¥14,000
●17φ×H17 (cm) 0.6t 5.0φ



STRAINER
こしてぼ

0925 3080 ¥8,700
●17φ×H11.5 (cm)
handle:24.5 (cm) 0.5t 1.1φ



木柄

共柄

パイプ柄

シリコン柄

NOODLE STRAINER
深型底平煮ざるうどんてぼ

0925 3000-(木柄) ¥8,930
0925 3001-(共柄) ¥8,470
0925 3002-(パイプ柄) ¥11,400
0925 3003-(シリコン柄) ¥10,600
●13φ×H20 (cm)
handle:18.5 (cm) 0.5t 2.2φ
※シリコン柄のみ handle:22 (cm)



STRAINER
こしてぼ/みそこし

0925 3310 ¥3,980
●12.5φ×H11.2×30 (全高) (cm)
●2.2φ



STRAINER
みそこし

0925 3320 ¥1,980
●10φ×H6.5×23 (全高) (cm)
●1.8φ

COLOR HANDLE STRAINER

カラーハンドル付てぼ



RED



BLUE



YELLOW



GREEN



COLOR HANDLE STRAINER

カラーハンドル付てぼ

L	●14φ×H18(cm)	¥6,600
S	●14φ×H13	¥6,200

●シリコンハンドル ●各色共通価格

商品コード

SIZE	レッド	ブルー	イエロー	グリーン
L	0925 3151	0925 3152	0925 3153	0925 3154
S	0925 3141	0925 3142	0925 3143	0925 3144

NOODLE STRAINER

てぼ/シリコンハンドル

0925 3150-L	¥6,400
●14φ×H18(cm)	
0925 3140-S	¥6,100
●14φ×H13	



木柄

NOODLE STRAINER

丸底うどんてぼ/木柄

0925 3040-L	¥8,900
●13.5φ×H17.5(cm)	
0925 3050-S	¥8,600
●12.5φ×H16.5	
●handle:18.5(cm) 0.5t 2.2φ	



共柄

NOODLE STRAINER

丸底うどんてぼ/共柄

0925 3041-L	¥8,500
●13.5φ×H17.5(cm)	
0925 3051-S	¥8,300
●12.5φ×H16.5	
●handle:18.5(cm) 0.5t 2.2φ	



パイプ柄

NOODLE STRAINER

丸底うどんてぼ/パイプ柄

0925 3042-L	¥10,500
●13.5φ×H17.5(cm)	
0925 3052-S	¥10,000
●12.5φ×H16.5	
●handle:18.5(cm) 0.5t 2.2φ	



シリコンハンドル

NOODLE STRAINER

丸底うどんてぼ/シリコンハンドル

0925 3043-L	¥9,800
●13.5φ×H17.5(cm)	
0925 3053-S	¥9,400
●12.5φ×H16.5	
●handle:22(cm) 0.5t 2.2φ	



木柄

NOODLE STRAINER

底平煮ざる/一体成形/木柄

0925 3451-L	¥6,200
●17φ×H15.5(cm)	
0925 3461-M	¥5,800
●16.2φ×H14.5	
0925 3471-S	¥5,400
●15.2φ×H13.5	
●handle:18.5 0.5t 2.5φ6P	



共柄

NOODLE STRAINER

底平煮ざる/一体成形/共柄

0925 3452-L	¥5,600
●17φ×H15.5(cm)	
0925 3462-M	¥5,200
●16.2φ×H14.5	
0925 3472-S	¥4,800
●15.2φ×H13.5	
●handle:18.5 0.5t 2.5φ6P	



パイプ柄

NOODLE STRAINER

底平煮ざる/一体成形/パイプ柄

0925 3453-L	¥7,900
●17φ×H15.5(cm)	
0925 3463-M	¥7,600
●16.2φ×H14.5	
0925 3473-S	¥7,200
●15.2φ×H13.5	
●handle:18.5 0.5t 2.5φ6P	



シリコンハンドル

NOODLE STRAINER

底平煮ざる/一体成形/シリコンハンドル

0925 3450-L	¥6,500
●17φ×H15.5(cm)	
0925 3460-M	¥6,200
●16.2φ×H14.5	
0925 3470-S	¥5,900
●15.2φ×H13.5	
●handle:18.5 0.5t 2.5φ6P	



SPAGHETTI STRAINER

スパゲッティてぼ/M

- 0925 3065—(木柄) ¥10,000
- 0925 3067—(パイプ柄) ¥11,800
- 13.5φ×H18(cm)
- handle:18.5(cm) 0.5t 1.5φ

SPAGHETTI STRAINER

スパゲッティてぼ/L

- 0925 3060—(木柄) ¥11,100
- 0925 3062—(パイプ柄) ¥12,600
- 15.5φ×H22(cm)
- handle:18.5(cm) 0.5t 1.5φ

SPAGHETTI STRAINER

スパゲッティてぼ/深型

- 0925 3070—(木柄) ¥11,100
- 0925 3072—(パイプ柄) ¥12,600
- 11.5φ×H30(cm)
- handle:18.5(cm) 0.5t 1.5φ

SPAGHETTI STRAINER

スパゲッティてぼ/シリコンハンドル

- 0925 3068—M ¥11,000
- 13.5φ×H18(cm)
- 0925 3063—L ¥11,800
- 15.5φ×H22
- 0925 3073—深型 ¥11,800
- 11.5φ×H30
- handle:22 0.5t 1.5φ



木柄

NOODLE STRAINER
平底うどん揚げ/木柄

- 0925 3195 ¥12,400
- 18.7φ×H17(cm)
- handle:18.5(cm) 0.5t 3.0φ



共柄

NOODLE STRAINER
平底うどん揚げ/共柄

- 0925 3196 ¥12,000
- 18.7φ×H17(cm)
- handle:18.5(cm) 0.5t 3.0φ



パイプ柄

NOODLE STRAINER
平底うどん揚げ/パイプ柄

- 0925 3197 ¥13,600
- 18.7φ×H17(cm)
- handle:18.5(cm) 0.5t 3.0φ



シリコンハンドル

NOODLE STRAINER
平底うどん揚げ/シリコンハンドル

- 0925 3198 ¥12,600
- 18.7φ×H17(cm)
- handle:22(cm) 0.5t 3.0φ



木柄

NOODLE STRAINER
底平煮ざる/木柄

- 0925 3010—L ¥9,400
- 16.5φ×H16(cm)
- 0925 3020—M ¥9,000
- 15φ×H15
- 0925 3030—S ¥8,250
- 13.5φ×H14
- handle:18.5 0.5t 2.2φ



共柄

NOODLE STRAINER
底平煮ざる/共柄

- 0925 3011—L ¥8,900
- 16.5φ×H16(cm)
- 0925 3021—M ¥8,200
- 15φ×H15
- 0925 3031—S ¥7,900
- 13.5φ×H14
- handle:18.5 0.5t 2.2φ



パイプ柄

NOODLE STRAINER
底平煮ざる/パイプ柄

- 0925 3012—L ¥11,300
- 16.5φ×H16(cm)
- 0925 3022—M ¥10,300
- 15φ×H15
- 0925 3032—S ¥9,800
- 13.5φ×H14
- handle:18.5 0.5t 2.2φ



シリコンハンドル

NOODLE STRAINER
底平煮ざる/シリコンハンドル

- 0925 3013—L ¥10,500
- 16.5φ×H16(cm)
- 0925 3023—M ¥9,500
- 15φ×H15
- 0925 3033—S ¥9,000
- 13.5φ×H14
- handle:22 0.5t 2.2φ



NOODLE STRAINER
角てぼ/縦型/木柄

0925 3100-L	¥11,000
●18×11.5×H14 (cm)	
0925 3105-S	¥9,300
●18×11.5×H8.5	
handle:18.5 (cm) 0.7t 2.2φ	



NOODLE STRAINER
角てぼ/縦型/パイプ柄

0925 3102-L	¥12,000
●18×11.5×H14 (cm)	
0925 3107-S	¥11,500
●18×11.5×H8.5	
handle:18.5 (cm) 0.7t 2.2φ	



NOODLE STRAINER
角てぼ/縦型/シリコンハンドル

0925 3103-L	¥11,200
●18×11.5×H14 (cm)	
0925 3108-S	¥10,700
●18×11.5×H8.5	
handle:22 (cm) 0.7t 2.2φ	



NOODLE STRAINER
角てぼ/横型/パイプ柄

0925 3092-L	¥12,000
●18×11.5×H14 (cm)	
0925 3097-S	¥11,500
●18×11.5×H8.5	
handle:18.5 (cm) 0.7t 2.2φ	



NOODLE STRAINER
角てぼ/横型/木柄

0925 3090-L	¥11,600
●18×11.5×H14 (cm)	
0925 3095-S	¥9,500
●18×11.5×H8.5	
handle:18.5 (cm) 0.7t 2.2φ	



NOODLE STRAINER
角てぼ/横型/シリコンハンドル

0925 3093-L	¥10,600
●18×11.5×H14 (cm)	
0925 3098-S	¥8,700
●18×11.5×H8.5	
handle:22 (cm) 0.7t 2.2φ	



NOODLE STRAINER
角型うどん揚げ/木柄

0925 3190	¥15,100
●17.5×15.2×H13 (cm)	
handle:18.5 (cm) 0.6t 2.2φ	



NOODLE STRAINER
角型うどん揚げ/共柄

0925 3191	¥14,800
●17.5×15.2×H13 (cm)	
handle:18.5 (cm) 0.6t 2.2φ	



NOODLE STRAINER
角型うどん揚げ/パイプ柄

0925 3192	¥16,000
●17.5×15.2×H13 (cm)	
handle:18.5 (cm) 0.6t 2.2φ	



NOODLE STRAINER
角型うどん揚げ/シリコンハンドル

0925 3193	¥14,600
●17.5×15.2×H13 (cm)	
handle:22 (cm) 0.6t 2.2φ	



NOODLE STRAINER
そば揚げ/縦型

0990 6550 - 18 cm	¥8,700
●18φ (cm)	
0990 6551 - 21	¥9,200
●21φ	
0990 6552 - 24	¥10,500
●24φ	
●handle:36(cm) 0.6t 3.0φ	



NOODLE STRAINER
そば揚げ/横型

0990 6560 - 18 cm	¥8,600
●18φ (cm)	
0990 6561 - 21	¥8,900
●21φ	
0990 6562 - 24	¥10,200
●24φ	
●handle:27(cm) 0.6t 3.0φ	



NOODLE STRAINER
そば揚げ/横型/シリコンハンドル

0990 6565 - 18 cm	¥8,200
●18φ (cm)	
0990 6566 - 21	¥8,700
●21φ	
0990 6567 - 24	¥10,000
●24φ	
●handle:27(cm) 0.6t 3.0φ	



SKIMMER
丸かす揚げ/板ハンドル

0925 3611 23 cm	¥5,700
●23φ (cm)	
全長:67.5(cm) handle:47.5(cm)	
0925 3621 20	¥5,200
●20φ	
全長:59 handle:40	
0925 3631 17	¥4,600
●17φ	
全長:47 handle:31	
●0.7t 2.2φ	
●ツバ付できます。	



SKIMMER
丸かす揚げ/パイプハンドル

0925 3610 23 cm	¥7,500
●23φ (cm)	
全長:67.5(cm) handle:47.5(cm)	
0925 3620 20	¥6,650
●20φ	
全長:59 handle:40	
0925 3630 17	¥5,650
●17φ	
全長:47 handle:31	
●0.7t 2.2φ	



OIL STRAINER
背油こし(丸かす揚げ)

0990 6581 - 20 cm	¥6,700
●20φ 全長:41(cm)	
0990 6580 - 23	¥7,550
●23φ 全長:43.5	
●0.7t 2.2φ	



SKIMMER
角かす揚げ/パイプハンドル

0925 3510-L	¥7,600
●18×22.5(cm) 全長:70(cm)	
0925 3520-M	¥6,400
●14×19 全長:57.5	
●0.7t 2.2φ	



SKIMMER
角かす揚げ/板ハンドル

0925 3511-L	¥5,850
●18×22.5(cm) 全長:70(cm)	
0925 3521-M	¥5,100
●14×19 全長:57.5	
●0.7t 2.2φ	
0925 3531-S	¥4,300
●10×14 全長:43.5	
●0.6t 2.2φ	
●ツバ付できます。	



SQ SKIMMER
スクエア スキンマー

0925 3590	¥5,400
●15×15(cm) 全長:45(cm)	
●0.6t 2.2φ	



COLANDER
パイプ柄 スクイ玉揚

0990 6500 - 特大	¥14,000
●28×25 (cm) 全長:62 (cm)	
0990 6501 - 大	¥13,100
●25×20 全長:58	
0990 6502 - 中	¥10,500
●22×19 全長:46.5	
0990 6503 - 小	¥9,500
●19×16 全長:38.5	
●0.6t 2.2φ	



●特注で、ハンドル付きも
できます。



COLANDER
パイプ柄 丸型 スクイ玉揚

0990 6540	¥15,000
●27φ (cm) 全長:62 (cm) 0.6t 2.2φ	



COLANDER
パンチング給食用スクイ網

0990 6515 - 丸型	¥18,000
●24φ (cm)	
0990 6520 - すいのう型	¥23,500
●28×25	
●handle:101 (cm) 0.6t 3.0φ	



COLANDER
スクイザル パイプ柄

0990 6324 - 24 cm	¥13,900
●25φ×H7 (cm)	
0990 6326 - 26	¥14,500
●27φ×H7.5	
0990 6228 - 28	¥15,100
●28.5φ×H8	
0990 6230 - 30	¥15,500
●30.5φ×H8.5	
0990 6233 - 33	¥16,200
●33.5φ×H9	
●handle:21 (cm) 0.6t 2.2φ	



NOODLE STRAINER
尺長パンチングそば揚げ

0990 6510	¥11,900
●21φ (cm)	
●handle:50 (cm) 0.6t 3.0φ	



COLANDER
ストレーナー/フック付

0990 6354 - 24 cm	¥13,500
●25φ×H7 (cm)	
0990 6356 - 26	¥14,000
●27φ×H7.5	
0990 6358 - 28	¥14,500
●28.5φ×H8	
0990 6360 - 30	¥15,100
●30.5φ×H8.5	
0990 6363 - 33	¥15,600
●33.5φ×H9	
●handle:22.5 (cm) 0.6t 2.2φ	



COLANDER
スクイザル

0990 6530 (柄長)	¥25,000
●30φ×H100 (cm)	
●handle:70 (cm) 0.6t 2.2φ	



補強付



SKIMMER
角かす揚げ/長柄パイプハンドル

0925 3570	¥17,500
0925 3575 - 補強付	¥21,000
●18×22.5 (cm) 全長:100 (cm)	



COLANDER/OBLONG
パンチ浅角バット

0990 3006	6枚取	¥15,300
●33.7×48.1×H5.2 (cm)		
0990 3008	8	¥12,000
●29.4×40.9×H4.3		
0990 3010	10	¥9,900
●27×35.5×H4.2		
0990 3012	12	¥8,250
●26×32.5×H4.2		
0990 3015	15	¥7,200
●23.2×29.7×H4.2		
0990 3018	18	¥7,100
●20.6×26.7×H3.6		
0990 3021	21	¥5,800
●20×24.8×H3.4		
0990 3050	キャビネット判	¥4,000
●16.8×20.8×H3		
●0.6t 2.2φ		



FOOD STORAGE PAN PERFORATED
穴付角バット

0990 4986	6枚取	¥5,950
●33.8×48.2×H8 (cm)		
0990 4988	8	¥4,600
●29.5×41×H6.7		
0990 4990	10	¥3,300
●27×35.5×H6.3		
0990 4992	12	¥3,100
●26×32.5×H5.3		



●OPTIONAL ハンドル付

MULTI PURPOSE BASKET
角ざる

0990 9100-L	¥45,000
●54×42.0×H18 (cm)	
0990 9110-M	¥44,000
●49×38.5×H16	
●0.8t 6.0φ	



P.BASKET
パンチング具材網 (ハンドル付)

0990 9250	¥35,700
●60×42×H4 (cm) 1.0t 3.0φ5P	
(ハンドル除く)	

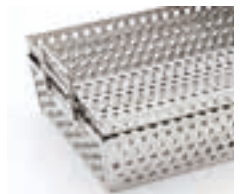

STACKING CONTAINER
スタッキングコンテナ

0990 9130	¥49,500
●53×30×H10 (cm) 1.0t 10φ20P	
●受注生産	



STACKING CONTAINER
スタッキングコンテナ

0990 9120	¥51,500
●40×30×H9.5 (cm) 0.8t 3φ5P	
●受注生産	



P.BASKET
パンチング 角ざる

0990 9200	¥34,500
●40.8×29.5×H10.5 (cm)	
●10×10角穴 15P	

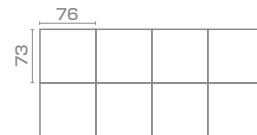
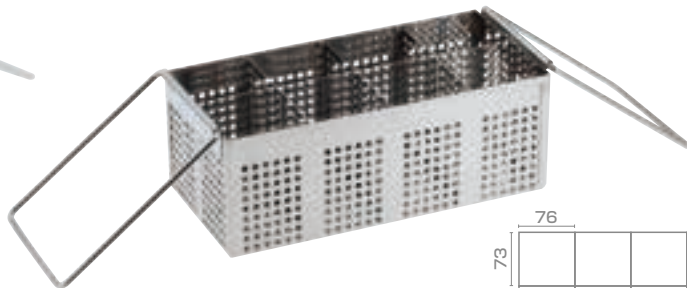

DISINFECTION BASKET
消毒かご/8ツ仕切

0950 0080 ¥39,600
●32×15.5×H12 (cm)

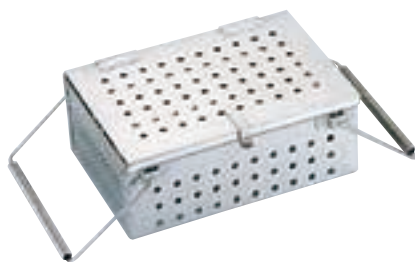

●STACKABLE

DISINFECTION BASKET for CUTLERY
スプーン消毒かご

0950 0010-L ¥11,800
●24×12×H8 (cm)
0950 0020-S ¥11,400
●18×12×H7
●0.6t 6.0φ

DISINFECTION BASKET for CHOPSTICKS
箸消毒かご

0950 0030-L ¥11,000
●26.0×10×H6.5 (cm)
0950 0040-S ¥10,400
●20.5×9×H5.5
●0.6t 6.0φ

SINK DUST BOX
三角コーナー

0995 0010 ¥7,700
●27×20.5×H10.5 (cm) 0.5t 2.2φ



0950 0060

DISINFECTION BASKET
消毒かご

0950 0060 ¥32,600
●30×28.5×H9 (cm) 0.7t 3.0φ
0950 0070 ¥21,000
●34×8×H8 0.7t 2.2φ
●特別注文品 SPECIAL ORDER

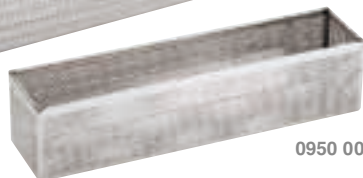

0950 0070



COLANDER
スプーンかご

0950 0050 ¥8,400
●20×8×H9 (cm) 0.8t 2.2φ



MIXING PADDLE
ミキシングパドル

0990 6000 ¥17,100
●107 (cm)
0990 6001 ¥17,700
●122



OIL STRAINER
角型油かす揚げ

0925 3550 ¥17,500
●23×20×全長54 (cm)

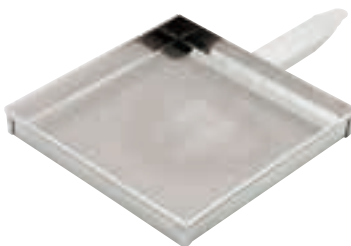

OIL STRAINER
角型油かす揚げ

0925 3560 ¥18,900
●23×23×全長30 (cm)
●0.5t 1.1φ2P



OPTION

SKIMMER
角かす揚げ/ツバ付
特注品

パンチング スペシャル メイド

BASKET / CONTAINER / DRAIN



CONTAINER
●62.5×43×H8 (cm)



BASKET
●46.5×34.5×H10 (cm)

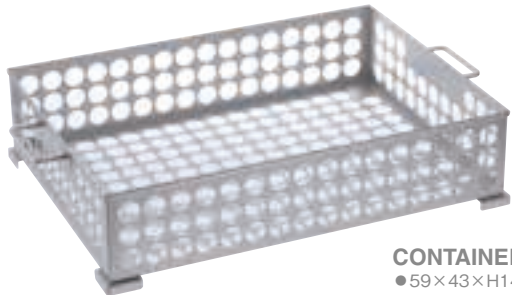

CONTAINER
●59×43×H14.5 (cm)
●ハンドル含まず



BASKET
●42×36.3×H16.5 (cm)
●ハンドル含まず

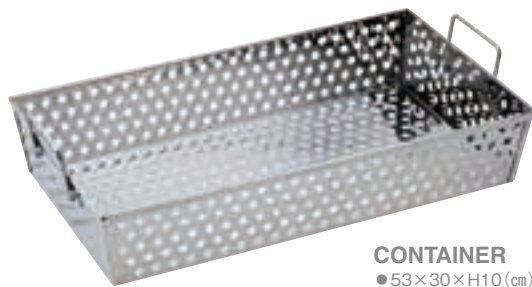

CONTAINER
●53×30×H10 (cm)
●10φ



BASKET
●31×13×H15.5 (cm)
●ハンドル含まず



DRAIN
●28×18×H12.5 (内) (cm)



CONTAINER
●44×26×H13 (cm)
●5.0φ



DRAIN
●26.7×26.7×H18.5 (内) (cm)



BOIL BASKET
●27φ×H27 (cm)



STRAINER
●30×30 (cm)
●ハンドル長さ50 (cm)



TEMPURA RING-3
木柄 3連 天ぷらリング

0995 0060 ¥17,500
●9φ×27×H19.5(cm)



TEMPURA RING-3
共柄 3連 天ぷらリング

0995 0053 ¥19,800
●10φ×30×H20(cm)



TEMPURA RING-4
共柄 4連 天ぷらリング

0995 0054 ¥21,000
●9φ×36×H20.5(cm)



TEMPURA RING-5
共柄 5連 天ぷらリング

0995 0055 ¥25,600
●10φ×50×H20.5(cm)



TEMPURA RING-6
共柄 6連 天ぷらリング

0995 0056 ¥28,500
●9φ×54×H20(cm)

TEMPURA RINGS (ST.ST)



ハンドルの付け根にも裏側にも補強板付き。



TEMPURA RING-4
かき揚げリング S

0995 0030 ¥19,600

●11φ×H10(cm) 0.8t 5.0φ



手が熱くならない様にハンドルを伸ばしました。



TEMPURA RING-4
長柄木柄4連かき揚げリング

0995 0032 ¥23,700

●11φ×H15(cm)
handle:29(cm) 0.8t 5.0φ20P



TEMPURA RING-4
かき揚げリング M

0995 0031 ¥22,600

●11φ×H15(cm) 0.8t 5.0φ



TEMPURA RING-2
かき揚げリング M

0995 0021 ¥11,800

●12φ×H10(cm) 0.8t 5.0φ



TEMPURA RING-2
かき揚げリング S

0995 0020 ¥10,300

●8φ×H10(cm) 0.8t 5.0φ



TEMPURA RING-2
かき揚げリング(穴なし)

0995 0022 ¥8,200

●8.5φ×H8.5(cm) 0.8t



RING/TEMPURA
かき揚げリング

0995 0000 ¥4,000

●10φ×H10(cm) 0.8t 8.0φ
Handle:15(cm)



CHINA CAP
スープこし (1mm穴)

0921 0150 - 15 cm	¥7,400
●15φ×31×H13 (cm)	
0921 0180 - 18	¥8,500
●18φ×36×H16	
0921 0210 - 21	¥11,000
●21φ×42×H18.5	
0921 0240 - 24	¥14,500
●24φ×50×H22	
0921 0270 - 27	¥23,000
●27φ×55×H25	
0921 0300 - 30	¥25,500
●30φ×61×H29	



NEW **COLANDER HOLDER**
スープこしスタンド

0921 2180 - 18 cm用	¥17,900
●18φ×H28 (cm)	
※特注サイズも出来ます。	



CONICAL STRAINER
パンチングスープこし

0992 0518 - 18 cm	¥8,500
●18φ×H17 (cm)	
0992 0521 - 21	¥11,000
●21φ×H20.5	
0992 0524 - 24	¥11,500
●24φ×H23.5	
●0.5t 1.5φ	



CHINOIS
シノア (25メッシュ)

0922 0210 - 21 cm	¥12,000
●21φ×42×H15.5 (cm)	
0922 0240 - 24	¥13,000
●24φ×47×H18	



PUNCHING STRAINER
パンチングストレーナー

0922 0115 - 15 cm	¥4,900
●16φ×H6.5 (cm)	
0922 0118 - 18	¥5,300
●20φ×H7	



CHINOIS
シノア / 板ハンドル

0922 0524 - 24 cm	¥7,800
●24φ×H18 (cm)	



CONICAL STRAINER
スープこし

0921 1120 - 12 cm	¥3,200
●12φ×H9 (cm) (板ハンドル)	
0921 1160 - 16	¥4,700
●16φ×H12.5	
0921 1180 - 18	¥5,200
●18φ×H14	
0921 1220 - 22	¥6,300
●22φ×H17.5	
0921 1250 - 25	¥7,600
●25φ×H20 (モナカハンドル)	



MESH STRAINER
ラウンドメッシュストレーナー

0922 0405 - 5 cm	¥600
●5.0φ×16 (cm)	
0922 0407 - 7	¥730
●6.5φ×18	
0922 0408 - 8	¥960
●7.7φ×19	



OIL STRAINERS (ST.ST)



OIL STRAINER

段付油こし 片手ハンドル(パンチ網仕様)

0992 0162	16-18 cm	¥6,150
替え網 S使用	21.5φ×H6(cm)	
0992 0202	20-22	¥7,600
替え網 M使用	25.5φ×H7.5	
0992 0242	24-26	¥8,650
替え網 L使用	29.5φ×H8	



OIL STRAINER

段付油こし 両手ハンドル(パンチ網仕様)

0992 0163	16-18 cm	¥5,600
替え網 S使用	21.5φ×H6(cm)	
0992 0203	20-22	¥7,000
替え網 M使用	25.5φ×H7.5	
0992 0243	24-26	¥8,000
替え網 L使用	29.5φ×H8	



OIL STRAINER

油こし 片手ハンドル(パンチ網仕様)

0992 1192	19 cm	¥5,250
替え網 S使用	20.0φ×H6(cm)	
0992 1212	21.5	¥5,450
替え網 S使用	23.0φ×H6	
0992 1232	23	¥6,550
替え網 M使用	24.5φ×H7	
0992 1262	26.5	¥7,400
替え網 L使用	27.5φ×H8	
0992 1302	30	¥8,000
替え網 L使用	30.5φ×H8	



OIL STRAINER

油こし 両手ハンドル(パンチ網仕様)

0992 1193	19 cm	¥4,800
替え網 S使用	20.0φ×H6(cm)	
0992 1213	21.5	¥5,400
替え網 S使用	23.0φ×H6	
0992 1233	23	¥6,000
替え網 M使用	24.5φ×H7	
0992 1263	26.5	¥6,900
替え網 L使用	27.5φ×H8	
0992 1303	30	¥7,700
替え網 L使用	30.5φ×H8	



OIL STRAINER/SPARE GAUZES

油こし用替えパンチ網

0992 0010	L	17.0φ (cm)	¥2,700
0992 0015	M	15.5φ	¥2,350
0992 0020	S	12.0φ	¥2,100

●1.1φ細目



段付油こし+KP組み合わせ





COLANDER
穴付きボール

0990 5820 -20 cm	¥1,500
●20φ×H7.0(cm) ●2.5φ	
0990 5822 -22	¥1,700
●22φ×H7.5 ●2.5φ	
0990 5824 -24	¥1,900
●24φ×H8.0 ●2.5φ	
0990 5826 -26	¥2,200
●26φ×H9.0 ●2.5φ	
0990 5828 -28	¥2,300
●28φ×H9.0 ●2.5φ	
0990 5830 -30	¥2,600
●30φ×H10.0 ●2.5φ	
0990 5832 -32	¥2,800
●32φ×H11.0 ●2.5φ	
0990 5834 -34	¥3,150
●34φ×H11.5 ●2.5φ	
0990 5836 -36	¥3,750
●36φ×H12.0 ●2.5φ	
0990 5838 -38	¥3,900
●38φ×H13.0 ●2.5φ	
0990 5840 -40	¥4,150
●40φ×H13.5 ●2.5φ	
0990 5850 -50	¥8,500
●48φ×H16.0 ●5φ	
0990 5860 -60	¥9,950
●58φ×H19.0 ●2.5φ	
0990 5870 -70	¥12,500
●68φ×H21.0 ●5φ	
●ST.ST	



COLANDER/EU
パンチボール/ユーロスタイル

0990 5922 -22 cm	¥3,500
●22φ×H9.4(cm)	
0990 5924 -24	¥3,800
●24φ×H9.8	
0990 5926 -26	¥4,200
●26φ×H10.7	
0990 5928 -28	¥4,700
●28φ×H11.6	
0990 5930 -30	¥5,300
●30φ×H12.5	
0990 5932 -32	¥5,800
●32φ×H13	
●18-8 ST.ST ●2φ4P	



COLANDER
パンチボール

0990 5964 -24 cm	¥3,100
●24φ×H8(cm)	
0990 5966 -26	¥3,400
●26φ×H8	
0990 5968 -28	¥3,900
●28φ×H9	
0990 5970 -30	¥4,300
●30φ×H9.9	
0990 5972 -32	¥4,600
●32φ×H10.6	
●18-8 ST.ST ●2φ4P	



COLANDER
穴付きボール/手付

0990 5753 -23 cm	¥3,200
●23φ×H8(cm)	
0990 5755 -25	¥3,650
●25φ×H8.7	
0990 5757 -27	¥4,100
●27φ×H9.2	
0990 5759 -29	¥4,500
●29φ×H10.2	
0990 5761 -31	¥4,950
●31φ×H10.6	
●18-8 ST.ST ●2.2φ4P	



COLANDER
ミキシングボール/手付

0990 5783 -23 cm	¥2,650
●23φ×H8(cm)	
0990 5785 -25	¥2,900
●25φ×H8.7	
0990 5787 -27	¥3,200
●27φ×H9.2	
0990 5789 -29	¥3,450
●29φ×H10.2	
0990 5791 -31	¥4,000
●31φ×H10.6	
●18-8 ST.ST	

MIXING BOWLS (ST.ST)



ボール+ボールザル/浅型



MIXING BOWL/DEEP
深型ボール

0990 5015 15 cm	¥2,000
●16φ×H6.5(cm)	
0990 5018 18	¥2,200
●19.5φ×H7	
0990 5021 21	¥2,580
●22.5φ×H8.5	
0990 5024 24	¥2,980
●26φ×H9.5	
0990 5027 27	¥3,600
●29φ×H10	
0990 5030 30	¥3,950
●32φ×H11.5	

浅型パンチボールの受け皿として利用できます。



MIXING BOWL/SHALLOW
浅型ボール

0990 5515 15 cm	¥1,840
●16φ×H4.7(cm)	
0990 5518 18	¥2,050
●19.5φ×H5.5	
0990 5521 21	¥2,260
●22.5φ×H6.3	
0990 5524 24	¥2,680
●26φ×H6.7	
0990 5527 27	¥3,100
●29φ×H7.5	
0990 5530 30	¥3,600
●32φ×H8.3	

パンチング盆ザルボールの受け皿として利用できます。



BOWL
盆ザルボール(盆型ボール)

0990 5615 15 cm	¥1,600
●16φ×H3.4(cm)	
0990 5618 18	¥1,800
●19.5φ×H3.4	
0990 5621 21	¥1,950
●22.5φ×H3.4	
0990 5624 24	¥2,300
●26φ×H3.4	
0990 5627 27	¥2,550
●29φ×H3.4	
0990 5630 30	¥2,900
●32φ×H3.4	

パンチングそばザルの受け皿として利用できます。



MIXING BOWL/DEEP
ミキシングボール/深型

0941 0120-20 cm	¥2,900
●20φ×H13(cm)	
●21-0 ST.ST	

※なくなり次第廃番です。



MIXING BOWL/SLANTED
ミキシングボール/スラント

0941 0216 16 cm	¥1,900
●16φ×H9.3(cm)	
0941 0218 18	¥2,200
●18φ×H10.3	
0941 0220 20	¥2,700
●20φ×H11.4	
0941 0222 22	¥3,000
●22φ×H12.5	
0941 0224 24	¥3,400
●24φ×H13.6	
0941 0226 26	¥3,900
●26φ×H14.6	

